

Data Sheet

5mm PIN Photodiode

PD333C

Features

- Fast response time
- High photo sensitivity
- Small junction capacitance

Descriptions

PD333C is a high speed and high sensitive PIN photodiode in a standard 5 ϕ plastic package. The device is spectrally matched to infrared emitting diode.



Applications

- High speed photo detector
- Security system
- Camera

Device Selection Guide

LED Part No.	Chip	Lens Color
	Material	
PD	Silicon	Water clear

Package Dimensions

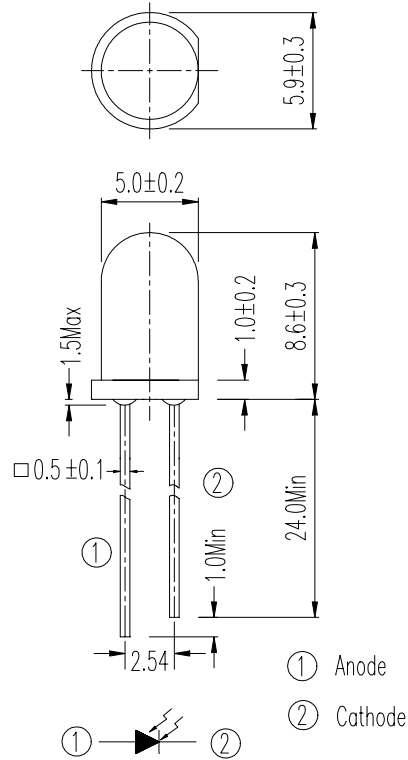

- Notes:** 1.All dimensions are in millimeters
2.Tolerances unless dimensions $\pm 0.25\text{mm}$

Absolute Maximum Ratings (Ta=25°C)

Parameter	Symbol	Rating	Units
Reverse Voltage	V_R	32	V
Power Dissipation	P_d	150	mW
Lead Soldering Temperature	T_{sol}	260	°C
Operating Temperature	T_{opr}	-25 ~ +85	°C
Storage Temperature	T_{stg}	-40 ~ +85	°C

Notes: *1:Soldering time ≤ 5 seconds.

Electro-Optical Characteristics (Ta=25°C)

Parameter	Symbol	Condition	Min.	Typ.	Max.	Units
Rang of Spectral Bandwidth	$\lambda_{0.5}$	-----	---	400-1100	---	nm
Wavelength of Peak Sensitivity	λ_p	-----	---		---	nm
Open-Circuit Voltage	V_{OC}	Ee=5m W/cm ² $\lambda_p=940\text{nm}$	---	0.41	---	V
Short- Circuit Current	I_{SC}	Ee=1m W/cm ² $\lambda_p=940\text{nm}$	---	20	---	μA
Reverse Light Current	I_L	Ee=1m W/cm ² $\lambda_p=940\text{nm}$ $V_R=5\text{V}$	---	20	---	
Dark Current	I_d	Ee=0m W/cm ² $V_R=10\text{V}$	---	---	10	nA
Reverse Breakdown	BV_R	Ee=0m W/cm ² $I_R=100\ \mu\text{A}$	32	170	---	V
Total Capacitance	C_t	Ee=0m W/cm ² $V_R=5\text{V}$ $f=1\text{MHZ}$	---	6	---	pF
Rise/Fall Time	t_r/t_f	$V_R=10\text{V}$ $R_L=1000\ \Omega$	---	10/10	---	nS

Typical Electro-Optical Characteristics Curves

Fig. 1 Power Dissipation vs. Ambient Temperature

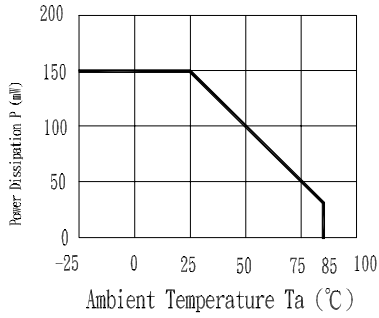

Fig. 2 Spectral Sensitivity

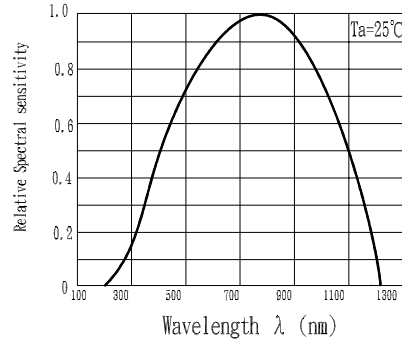

Fig. 3 Dark Current vs. Ambient Temperature

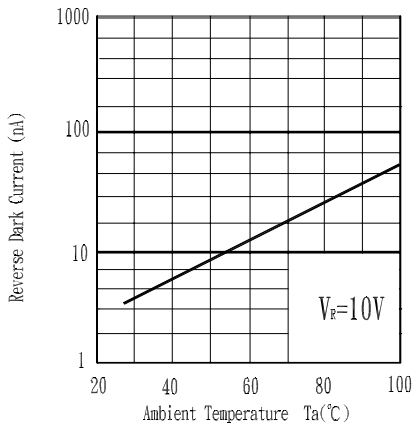

Fig. 4 Reverse Light Current vs. E_e

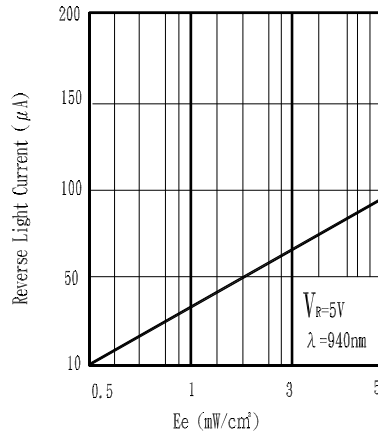

Fig. 5 Terminal Capacitance vs. Reverse Voltage

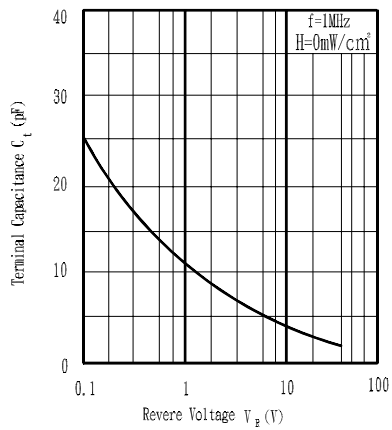
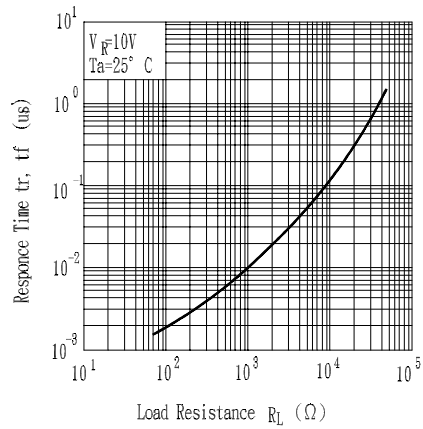

Fig. 6 Response Time vs. Load Resistance



Reliability Test Item And Condition

The reliability of products shall be satisfied with items listed below.

Confidence level : 90%

LTPD : 10%

NO.	Item	Test Conditions	Test Hours/ Cycles	Sample Sizes	Failure Judgement Criteria	Ac/Re
1	Solder Heat	TEMP : $260^{\circ}\text{C} \pm 5^{\circ}\text{C}$	10secs	22pcs		0/1
2	Temperature Cycle	H : $+85^{\circ}\text{C}$ 30mins \updownarrow 5mins L : -55°C 30mins	50Cycles	22pcs	$I_R \geq U \times 2$ $E_e \leq L \times 0.8$ $V_F \geq U \times 1.2$	0/1
3	Thermal Shock	H : $+100^{\circ}\text{C}$ 5mins \updownarrow 10secs L : -10°C 5mins	50Cycles	22pcs	U : Upper Specification	0/1
4	High Temperature Storage	TEMP. : $+100^{\circ}\text{C}$	1000hrs	22pcs	Limit	0/1
5	Low Temperature Storage	TEMP. : -55°C	1000hrs	22pcs	L : Lower Specification	0/1
6	DC Operating Life	$V_R=5\text{V}$	1000hrs	22pcs	Limit	0/1
7	High Temperature/ High Humidity	85°C / 85% R.H	1000hrs	22pcs		0/1